

1 2 3 4 5 6 7

D
C
B
A

D
C
B
A

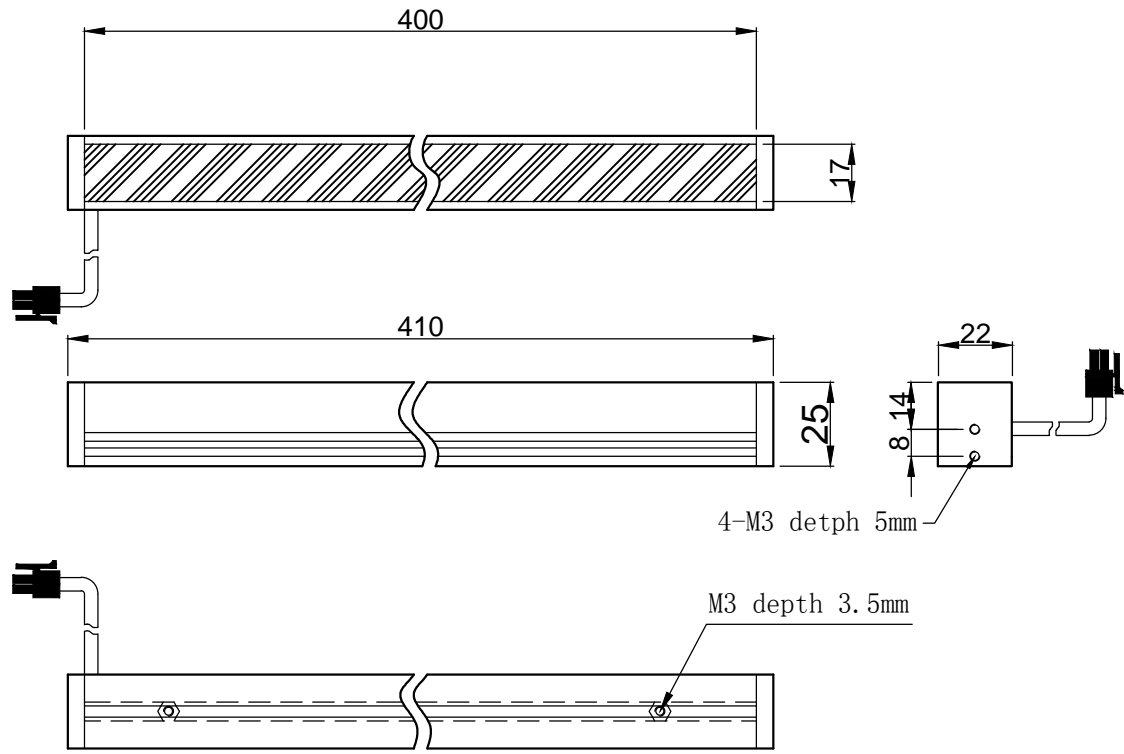

SPECIFICATIONS PARAMETER	
OPERATING VOLTAGE	DC24-26V
RATED CURRENT	IR, R / W, G, B 400/600mA
RATED POWER	IR, R / W, G, B 9.6/14.4W
PEAK CURRENT	IR, R / W, G, B 800/1200mA
PEAK POWER	IR, R / W, G, B 19.2/28.8W
WAVELENGTH OF LIGHT	IR 850-940 nm
	R 620-625nm
	G 520-530nm
	B 465-470nm
	W 6500-8000K



PART NAME	HL-LND-400		DATE	2014-9-23
UNIT: mm	TITLE	DRAWING LAYOUT	DWN. BY	
			CHKD. BY	
			APPD. BY	
			DWG. NO	

1 2 3 4 5 6 7