

1

2

3

4

5

6

7

D

D

C

C

B

B

A

A

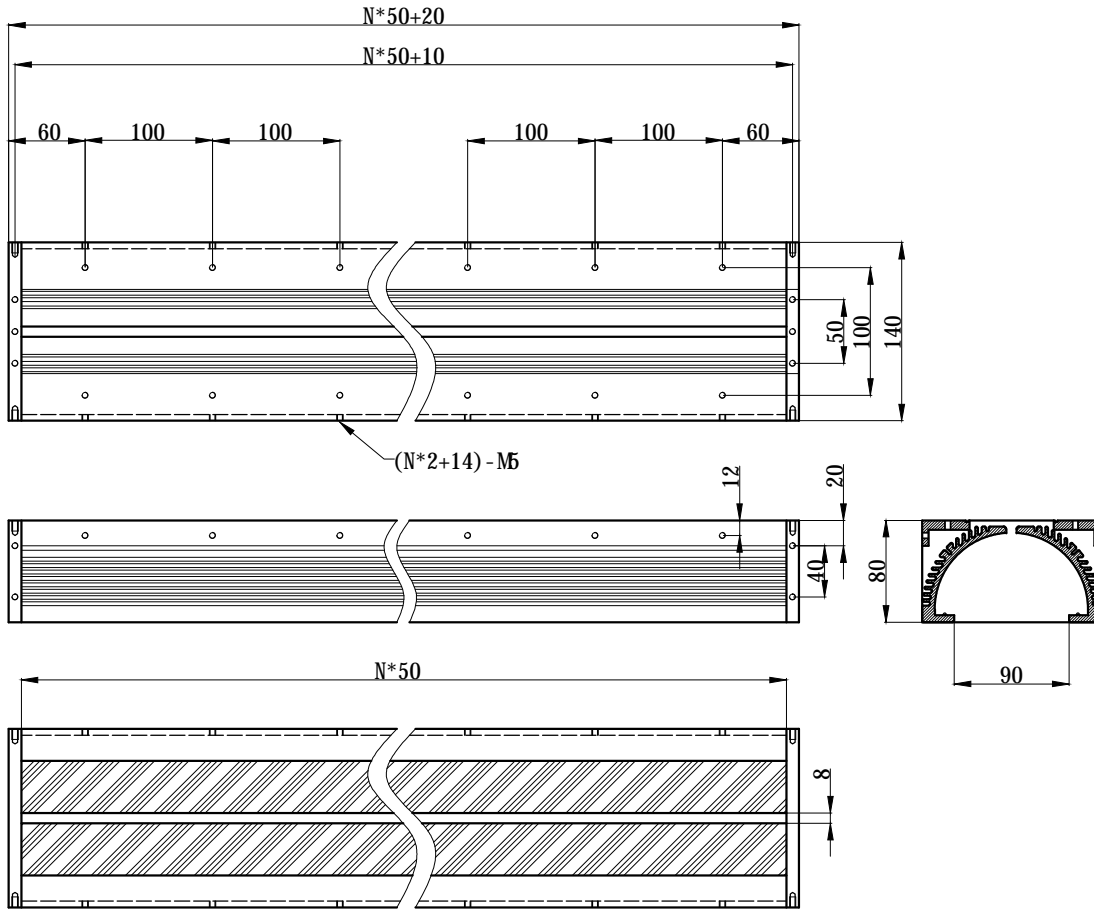

SPECIFICATIONS PARAMETER	
OPERATING VOLTAGE	DC48V
RATED CURRENT	IR, R / W, G, B N*500mA
RATED POWER	IR, R / W, G, B N*12W
PEAK CURRENT	IR, R / W, G, B N*1A
PEAK POWER	IR, R / W, G, B N*24W
WAVELENGTH OF LIGHT	IR 850 nm
	R 620-625nm
	G 520-530nm
	B 465-470nm
	W 6500-7000K



PART NAME	HL-DOML-N*75		DATE	2016-1-22
	UNIT: mm	TITLE	DRAWING LAYOUT	DWN. BY
			CHKD. BY	
			APPD. BY	
			DWG. NO	

1

2

3

4

5

6

7