

1 2 3 4 5 6 7

D
C
B
A

D
C
B
A

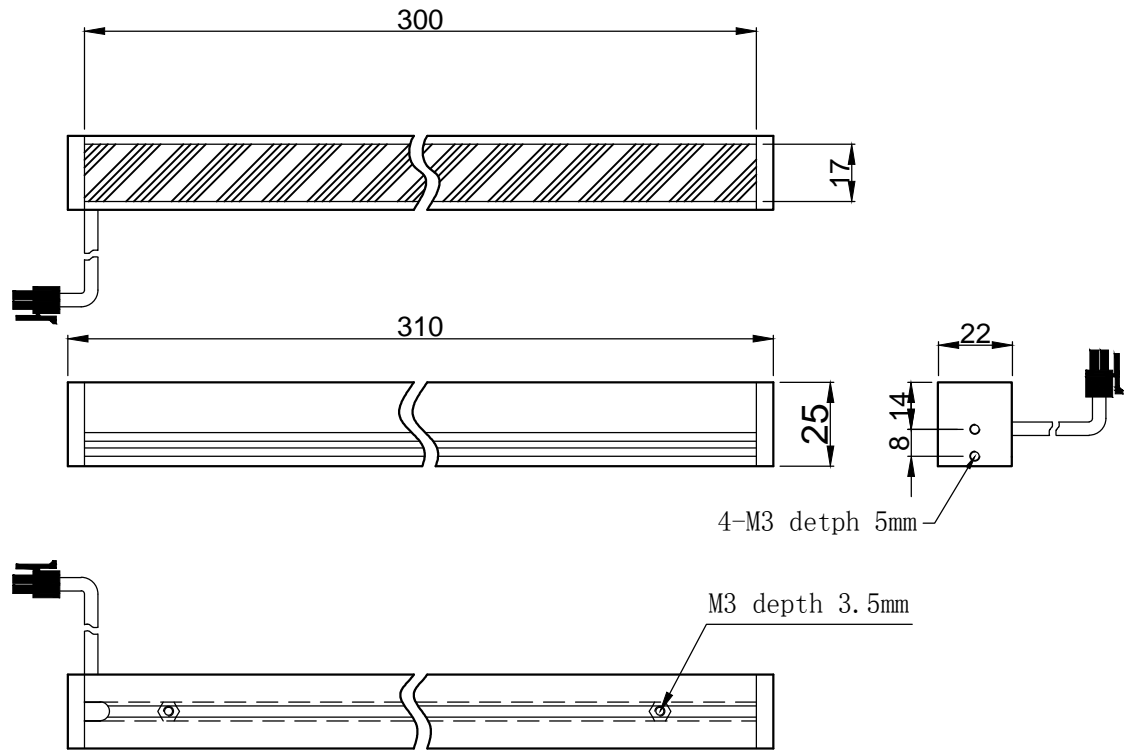

SPECIFICATIONS PARAMETER	
OPERATING VOLTAGE	DC24-26V
RATED CURRENT	IR, R / W, G, B 320/480mA
RATED POWER	IR, R / W, G, B 7.68/11.52W
PEAK CURRENT	IR, R / W, G, B 640/960mA
PEAK POWER	IR, R / W, G, B 15.76/23.04W
WAVELENGTH OF LIGHT	IR 940nm、830nm
	R 620-625nm
	G 520-530nm
	B 465-470nm
	W 6500-8000K



PART NAME	HL-LND-300		DATE	2013-9-23
UNIT: mm	TITLE	DRAWING LAYOUT	DWN. BY	
			CHKD. BY	
			APPD. BY	
			DWG. NO	

1 2 3 4 5 6 7