

1 2 3 4 5 6 7

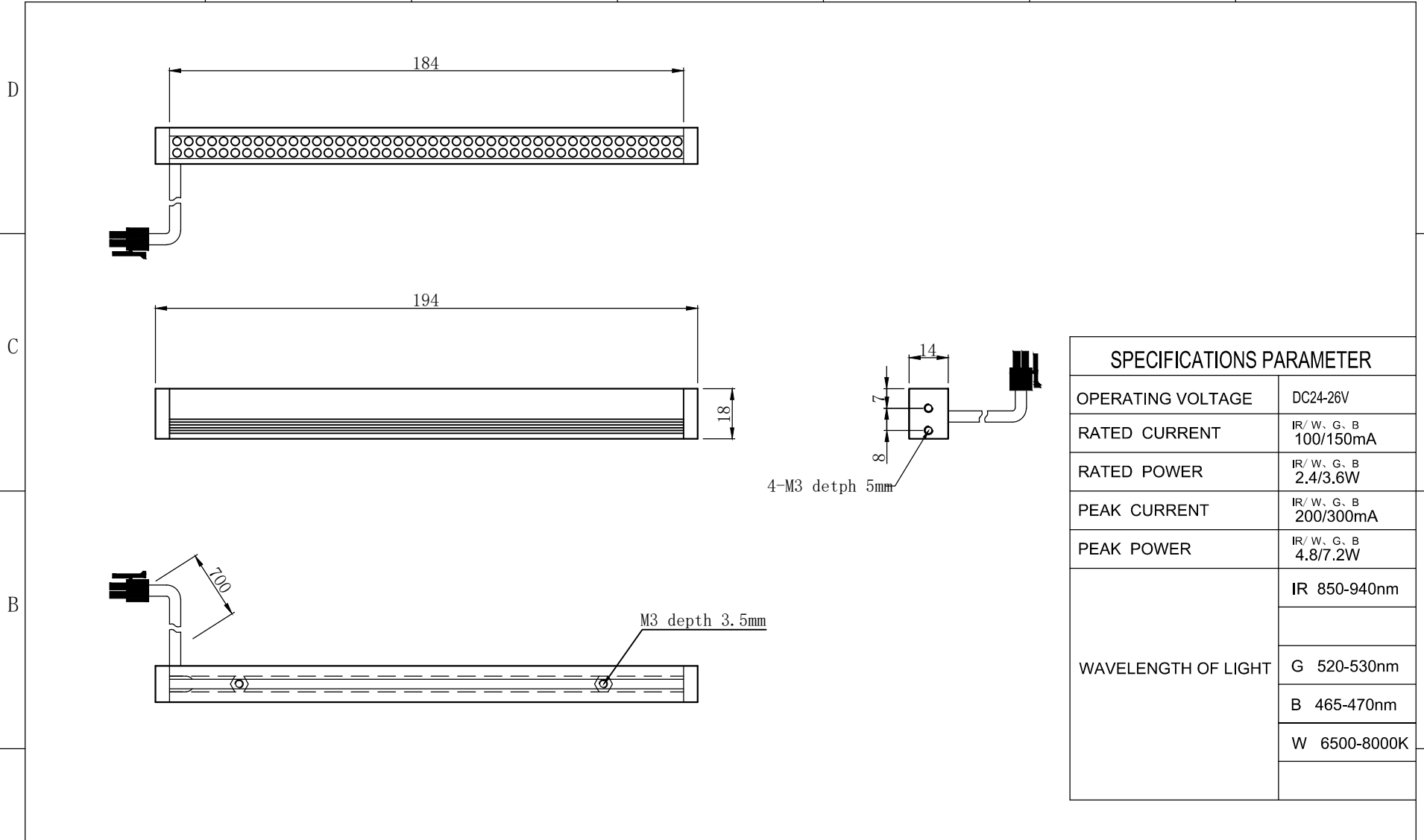

SPECIFICATIONS PARAMETER	
OPERATING VOLTAGE	DC24-26V
RATED CURRENT	IR/ W, G, B 100/150mA
RATED POWER	IR/ W, G, B 2.4/3.6W
PEAK CURRENT	IR/ W, G, B 200/300mA
PEAK POWER	IR/ W, G, B 4.8/7.2W
WAVELENGTH OF LIGHT	IR 850-940nm
	G 520-530nm
	B 465-470nm
	W 6500-8000K



PART NAME	HL-LS-184		DATE	2016-1-18
UNIT: mm	TITLE	DRAWING LAYOUT	DWN. BY	
			CHKD. BY	
			APPD. BY	
			DWG. NO	

1 2 3 4 5 6 7