

1 2 3 4 5 6 7

D
C
B
A

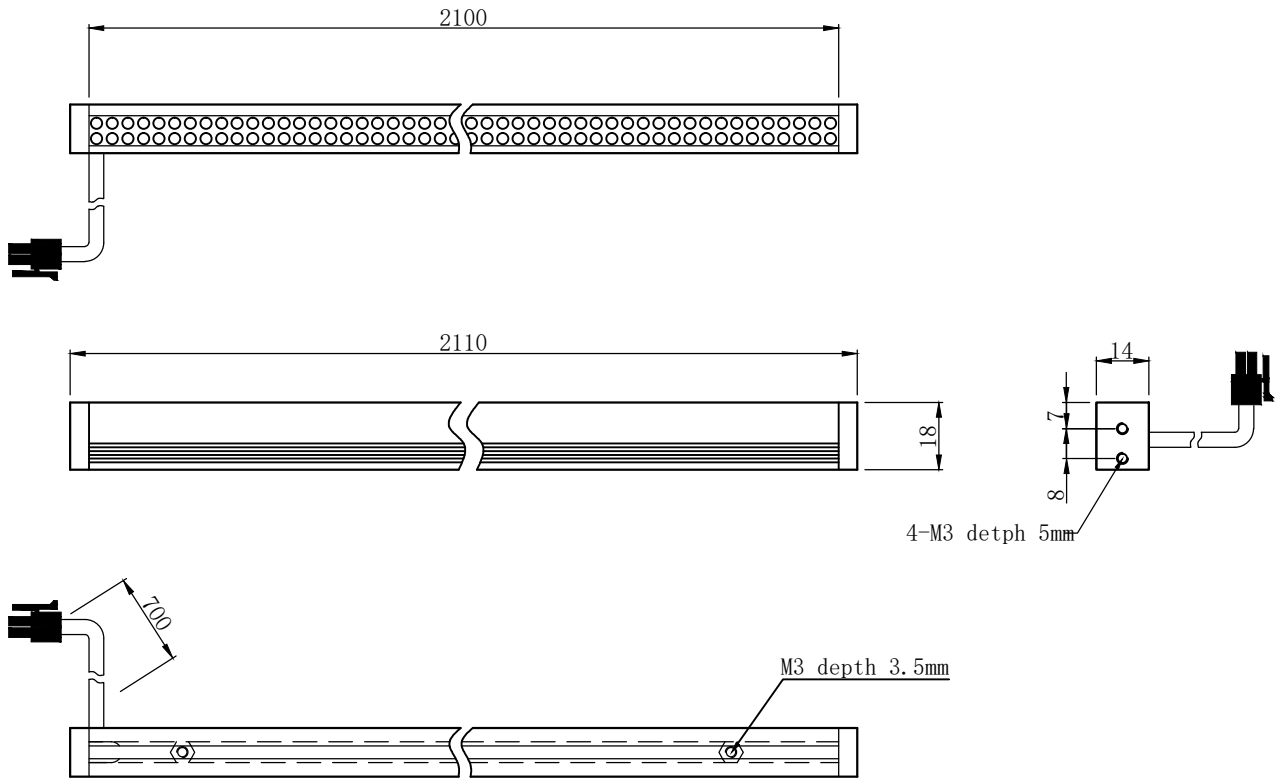

SPECIFICATIONS PARAMETER	
OPERATING VOLTAGE	DC24-26V
RATED CURRENT	IR, R/W, G, B 1200/1700mA
RATED POWER	IR, R/W, G, B 28.8/40.8W
PEAK CURRENT	IR, R/W, G, B 2.4/3.4A
PEAK POWER	IR, R/W, G, B 57.6/81.6W
WAVELENGTH OF LIGHT	IR 850-940nm
	R 620-625nm
	G 520-530nm
	B 465-470nm
	W 6500-8000K



PART NAME	HL-LS-2400		DATE	2016-1-18
			DWN. BY	
UNIT: mm	TITLE	DRAWING LAYOUT		CHKD. BY
				APPD. BY
				DWG. NO

1 2 3 4 5 6 7