

1

2

3

4

5

6

7

D

D

C

C

B

B

A

A

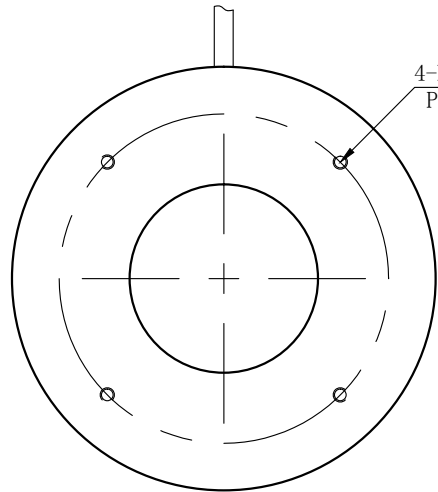

4-M3 depth 4
P.C.D 70

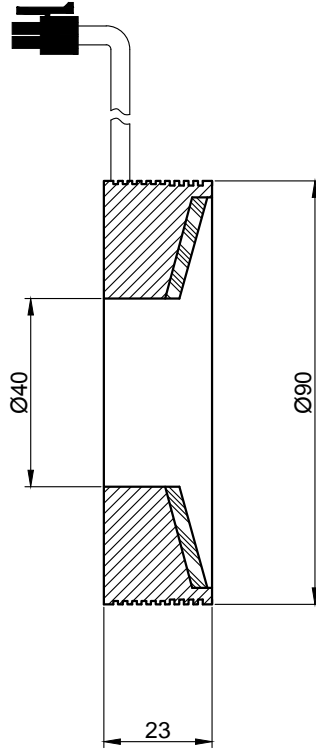

Ø40

Ø90

23

SPECIFICATIONS PARAMETER

OPERATING VOLTAGE	DC24-26V
RATED CURRENT	IR, R / W, G, B 210/300mA
RATED POWER	IR, R / W, G, B 5.04/7.2W
PEAK CURRENT	IR, R / W, G, B 420/600mA
PEAK POWER	IR, R / W, G, B 10.08/14.4W
WAVELENGTH OF LIGHT	IR 850-940nm
	R 620-625nm
	G 520-530nm
	B 465-470nm
	W 6500-7000K



PART NAME	HL-RD15-90-4	DATE	2014-9-23
UNIT: mm	TITLE	DRAWING LAYOUT	CHKD. BY
			APPD. BY
			DWG. NO

1

2

3

4

5

6

7