

1

2

3

4

5

6

7

D

D

C

C

B

B

A

A

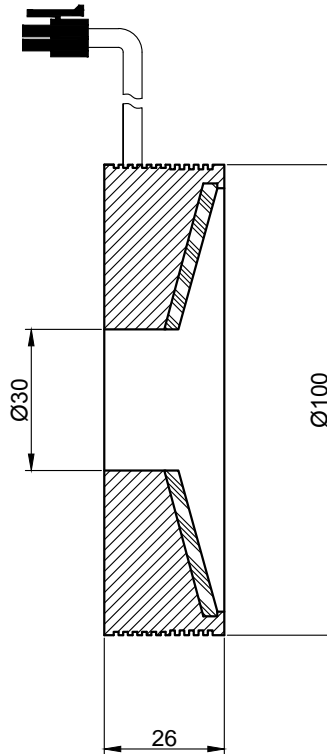
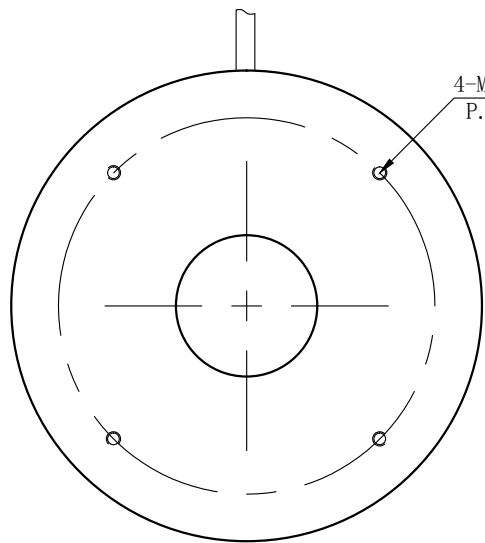

SPECIFICATIONS PARAMETER	
OPERATING VOLTAGE	DC24-26V
RATED CURRENT	IR, R / W, G, B 280/400mA
RATED POWER	IR, R / W, G, B 6.72/9.6W
PEAK CURRENT	IR, R / W, G, B 560/800mA
PEAK POWER	IR, R / W, G, B 13.44/19.2W
WAVELENGTH OF LIGHT	IR 850-940nm
	R 620-625nm
	G 520-530nm
	B 465-470nm
	W 6500-7000K



PART NAME	HL-RD15-100-5	DATE	2015-2-16
UNIT: mm	TITLE	DRAWING LAYOUT	CHKD. BY
			APPD. BY
			DWG. NO

1

2

3

4

5

6

7