

1 2 3 4 5 6 7

D

D

C

C

B

B

A

A

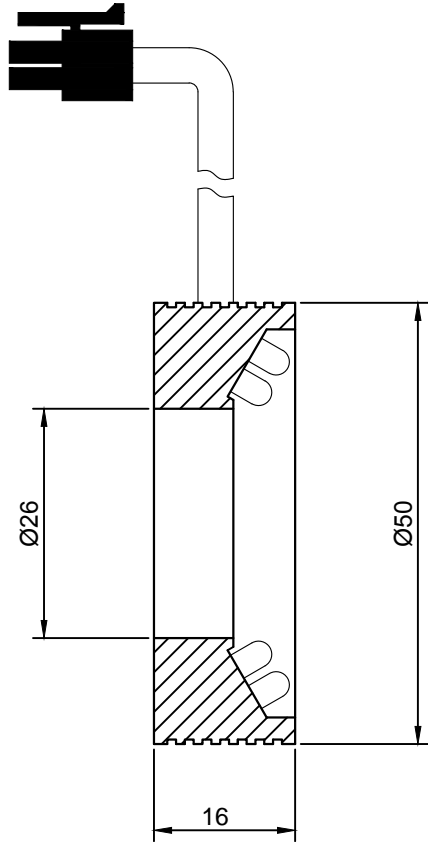
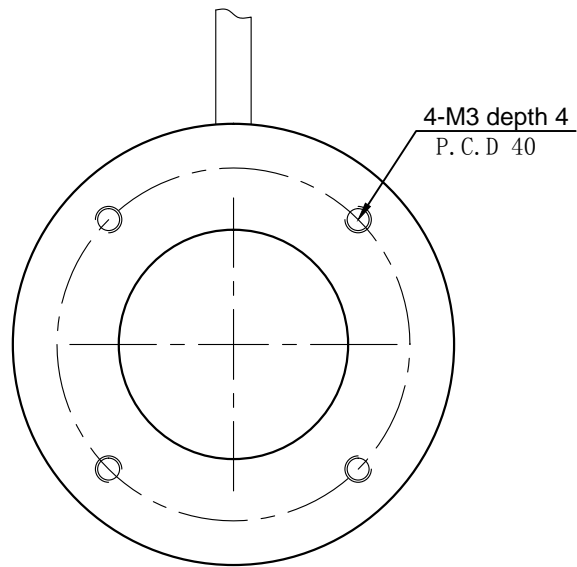

SPECIFICATIONS PARAMETER	
OPERATING VOLTAGE	DC24-26V
RATED CURRENT	IR / W. G. B 75/105mA
RATED POWER	IR / W. G. B 1.8/2.52W
PEAK CURRENT	IR / W. G. B 150/210mA
PEAK POWER	IR / W. G. B 3.6/5.04W
WAVELENGTH OF LIGHT	IR 850-940nm
	R 620-625nm
	G 520-530nm
	B 465-470nm
	W 6500-7000K



PART NAME	HL-R30-50-2		DATE	2014-12-19
UNIT: mm	TITLE	DRAWING LAYOUT	DWN. BY	
			CHKD. BY	
			APPD. BY	
			DWG. NO	

1 2 3 4 5 6 7