

1

2

3

4

5

6

7

D

D

C

C

B

B

A

A

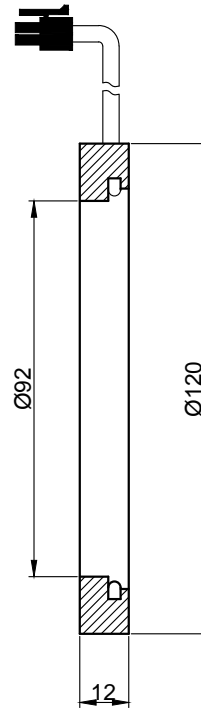
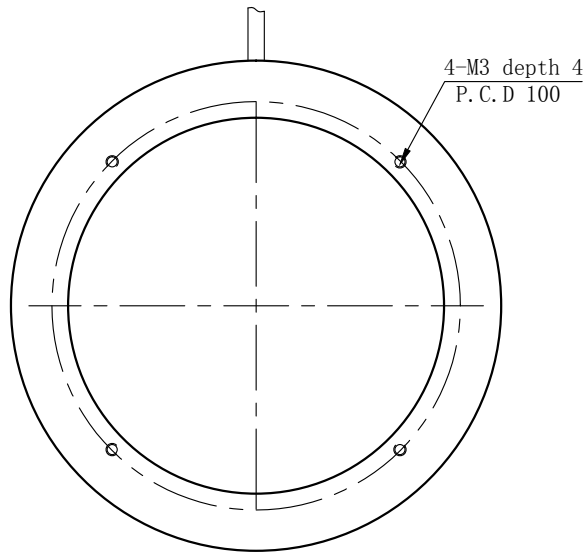

SPECIFICATIONS PARAMETER	
OPERATING VOLTAGE	DC24-26V
RATED CURRENT	IR, R / W, G, B 90/150mA
RATED POWER	IR, R / W, G, B 2.16/3.6W
PEAK CURRENT	IR, R / W, G, B 180/300mA
PEAK POWER	IR, R / W, G, B 4.32/7.2W
WAVELENGTH OF LIGHT	IR 850-940nm
	R 620-625nm
	G 520-530nm
	B 465-470nm
	W 6500-7000K



PART NAME	HL-R90-120-1		DATE	2013-6-8
	UNIT: mm	TITLE	DRAWING LAYOUT	DWN. BY
			CHKD. BY	
			APPD. BY	
			DWG. NO	

1

2

3

4

5

6

7