

1

2

3

4

5

6

7

D

D

C

C

B

B

A

A

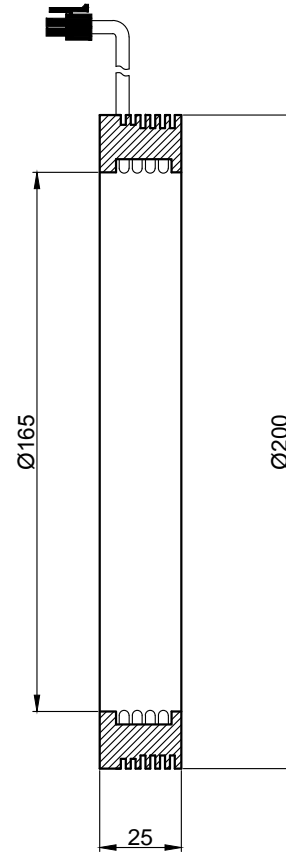
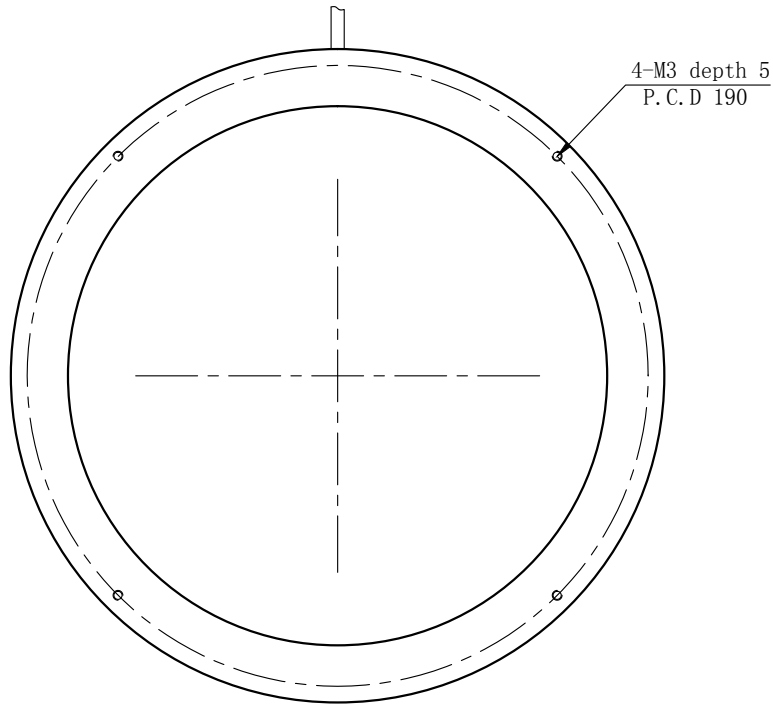

SPECIFICATIONS PARAMETER	
OPERATING VOLTAGE	DC24-26V
RATED CURRENT	IR、R / W、G、B 600/800mA
RATED POWER	IR、R / W、G、B 14.4/19.2W
PEAK CURRENT	IR、R / W、G、B 1200/1600mA
PEAK POWER	IR、R / W、G、B 28.8/38.4W
WAVELENGTH OF LIGHT	IR 850-940nm
	R 620-625nm
	G 520-530nm
	B 465-470nm
	W 6500-7000K



PART NAME	HL-R90-200-4		DATE	2013-6-8
UNIT: mm	TITLE	DRAWING LAYOUT	DWN. BY	
			CHKD. BY	
			APPD. BY	
			DWG. NO	

1

2

3

4

5

6

7