

1 2 3 4 5 6 7

D

D

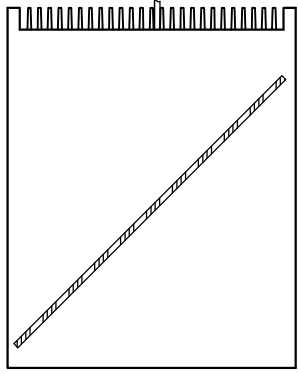
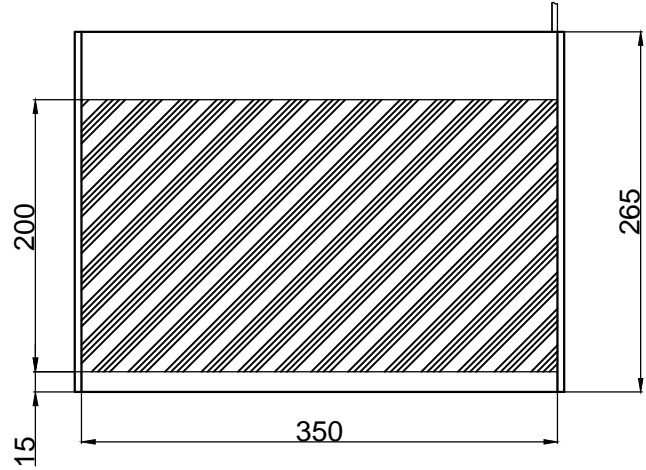

C

C

B

B

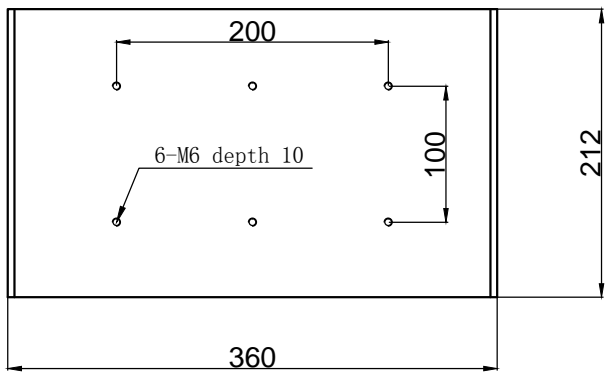

A

A

SPECIFICATIONS PARAMETER	
OPERATING VOLTAGE	DC24-26V
RATED CURRENT	IR, R / W, G, B, V 3/4A
RATED POWER	IR, R / W, G, B, V 72/96W
PEAK CURRENT	IR, R / W, G, B, V 6/8A
PEAK POWER	IR, R / W, G, B, V 144/192W
WAVELENGTH OF LIGHT	IR 850 nm
	R 620-625nm
	G 520-530nm
	B 465-470nm
	V 365-400nm
	W 6500-7000K



PART NAME	HL-CL-200-350	DATE	2013-11-21
UNIT: mm	TITLE	DWN. BY	
	DRAWING LAYOUT	CHKD. BY	
		APPD. BY	
		DWG. NO	

1 2 3 4 5 6 7